

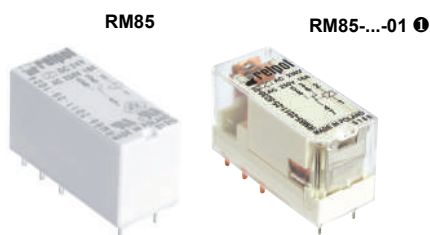





RM85

miniature relays



- Cadmium - free contacts • Height 15,7 mm
- 5000 V / 10 mm reinforced insulation
- For PCB and plug-in sockets
- Accessories: sockets and modules • AC and DC coils
- Available special versions: with transparent cover ❶; with the increased dielectric strength of the contact clearance ❷
- Compliance with standard PN-EN 60335-1
- Recognitions, certifications, directives: RoHS,     

Contact data

Number and type of contacts		1 CO, 1 NO ❷
Contact material		AgNi , AgNi/Au 5 µm, AgSnO ₂
Rated / max. switching voltage	AC	250 V / 440 V
Min. switching voltage		5 V AgNi, 5 V AgNi/Au 5 µm, 10 V AgSnO ₂
Rated load (capacity)	AC1	16 A / 250 V AC
	AC15	3 A / 120 V 1,5 A / 240 V (B300)
	AC3	750 W (single-phase motor)
	DC1	16 A / 24 V DC (see Fig. 3)
	DC13	0,22 A / 120 V 0,1 A / 250 V (R300)
Min. switching current		5 mA AgNi, 2 mA AgNi/Au 5 µm, 10 mA AgSnO ₂
Max. inrush current		30 A AgSnO ₂
Rated current		16 A
Max. breaking capacity	AC1	4 000 VA
Min. breaking capacity		0,3 W AgNi, 0,05 W AgNi/Au 5 µm, 1 W AgSnO ₂
Contact resistance		≤ 100 mΩ
Max. operating frequency	• at rated load	AC1 600 cycles/hour
	• no load	72 000 cycles/hour

Coil data

Rated voltage	50/60 Hz AC	12 ... 240 V
	DC	3 ... 110 V
Must release voltage		AC: ≥ 0,15 U _n DC: ≥ 0,1 U _n
Operating range of supply voltage		see Tables 1, 2 and Fig. 4, 5
Rated power consumption	AC	0,75 VA
	DC	0,4 ... 0,48 W

Insulation according to PN-EN 60664-1

Insulation rated voltage		400 V AC
Rated surge voltage		4 000 V 1,2 / 50 µs
Overvoltage category		III
Insulation pollution degree		3
Dielectric strength	• between coil and contacts	5 000 V AC type of insulation: reinforced
	• contact clearance	1 000 V AC type of clearance: micro-disconnection
		2 000 V AC contact 1 NO, type of clearance: full-disconnection ❷
Contact - coil distance	• clearance	≥ 10 mm
	• creepage	≥ 10 mm

General data

Operating / release time (typical values)		7 ms / 3 ms
Electrical life (number of cycles)	• resistive AC1	> 0,7 x 10 ⁵ 16 A, 250 V AC
		> 10 ⁴ 20 A, 250 V AC, 85 °C (RM85-3021-25-1...)
	• cosφ	see Fig. 2
	• DC L/R=40 ms	> 10 ⁵ 0,15 A, 220 V DC
Mechanical life (cycles)		> 3 x 10 ⁷
Dimensions (L x W x H) / Weight		29 x 12,7 x 15,7 mm / 14 g
Ambient temperature	• storage	-40...+85 °C
	• operating	AC: -40...+70 °C DC: -40...+85 °C -40...+70 °C ❶
Cover protection category		IP 40 ❶ or IP 67 PN-EN 60529
Environmental protection		RTII ❶ or RTIII PN-EN 116000-3
Shock resistance		30 g
Vibration resistance		10 g 10...150 Hz
Solder bath temperature / Soldering time		max. 270 °C / max. 5 s

The data in bold type pertain to the standard versions of the relays.

❶ For special version - relays in transparent cover: only available with IP 40 and RTII, operating temperature -40...+70 °C - see "Ordering codes"

❷ For special version with contact 1 NO: relays with increased contact gap, dielectric strength 2000 V AC - see "Ordering codes"

RM85

miniature relays

Coil data - DC voltage version

Table 1

Coil code	Rated voltage V DC	Coil resistance at 20 °C Ω	Acceptable resistance	Coil operating range V DC	
				min. (at 20 °C)	max. (at 20 °C)
1003	3	22	$\pm 10\%$	2,1	7,6
1005	5	60	$\pm 10\%$	3,5	12,7
1006	6	90	$\pm 10\%$	4,2	15,3
1009	9	200	$\pm 10\%$	6,3	22,9
1012	12	360	$\pm 10\%$	8,4	30,6
1018	18	710	$\pm 10\%$	12,6	45,9
1024	24	1 440	$\pm 10\%$	16,8	61,2
1036	36	3 140	$\pm 10\%$	25,2	91,8
1048	48	5 700	$\pm 10\%$	33,6	122,4
1060	60	7 500	$\pm 10\%$	42,0	153,0
1110	110	25 200	$\pm 10\%$	77,0	280,0

The data in bold type pertain to the standard versions of the relays.

Coil data - AC 50/60 Hz voltage version

Table 2

Coil code	Rated voltage V AC	Coil resistance at 20 °C Ω	Acceptable resistance	Coil operating range V AC 50 Hz	
				min. (at 20 °C)	max. (at 20 °C)
5012	12	100	$\pm 10\%$	9,6	13,2
5024	24	400	$\pm 10\%$	19,2	28,8
5048	48	1 550	$\pm 10\%$	38,4	57,6
5060	60	2 600	$\pm 10\%$	48,0	72,0
5110	110	8 900	$\pm 10\%$	88,0	132,0
5115	115	9 600	$\pm 10\%$	92,0	138,0
5120	120	10 200	$\pm 10\%$	96,0	144,0
5220	220	35 500	$\pm 10\%$	176,0	264,0
5230	230	38 500	$\pm 10\%$	184,0	276,0
5240	240	42 500	$\pm 15\%$	192,0	288,0

The data in bold type pertain to the standard versions of the relays.

PI84 (PI85)

Interface relay:
relay RM84 (RM85)
and socket
GZT80 or GZM80
- see www.relpol.com.pl



RM85

miniature relays

Dimensions

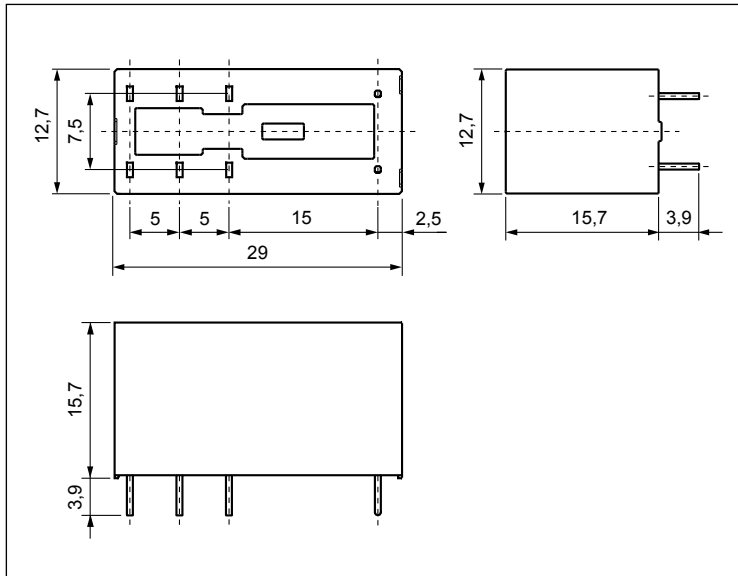

Pinout (solder side view)

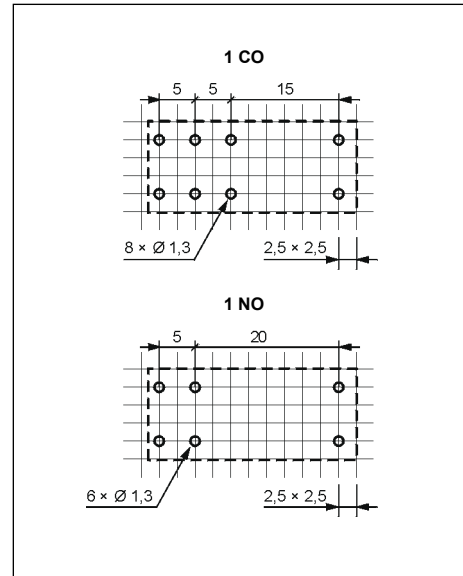

Connection diagrams (pin side view)

Connection diagrams for 1 CO and 1 NO relays showing terminal connections:

- 1 CO:** Terminals 14(8), 24(5), 11(7), 21(4), 12(6), 22(3) are connected to A1(1) and A2(2).
- 1 NO:** Terminals 14(8), 24(5), 11(7), 21(4) are connected to A1(1) and A2(2).

Terminal (pin)	A1(1); A2(2)	22(3); 21(4); 24(5); 12(6); 11(7); 14(8)
[mm]	Ø 0,6	0,5 x 0,9
Drilling hole:		
• for relays Ø 1,3 + 0,1 mm		
• for sockets Ø 1,5 + 0,1 mm		

RM85 terminals are doubled for each contact. Both terminals are to be used while connecting to load.

Connection of GZ... sockets

Diagram showing the connection of GZ... sockets to the relay terminals:

- Terminal 21 is connected to terminal 11.
- Terminal 14 is connected to terminal 24.
- Terminal 12 is connected to terminal 22.
- Terminal -A2 is connected to terminal +A1.

Clamp bridge Cu wire min. 1,5 mm²

Note: Loads above 12 A (GZT80, GZM80) or 10 A (GZS80, GZMB80) require bridging pairs of terminals: 11 with 21, 12 with 22, 14 with 24. Loads up to 12 A or 10 A do not require bridging of common terminals (such bridges may be fixed, however).

GZMB80

Spring terminals
plug-in socket
for RM84, RM85...,
RMB841, RMB851,
RM87L, RM87P
- see page 7.



Electrical life at AC resistive load.
Switching frequency: 600 cycles/hour

Fig. 1

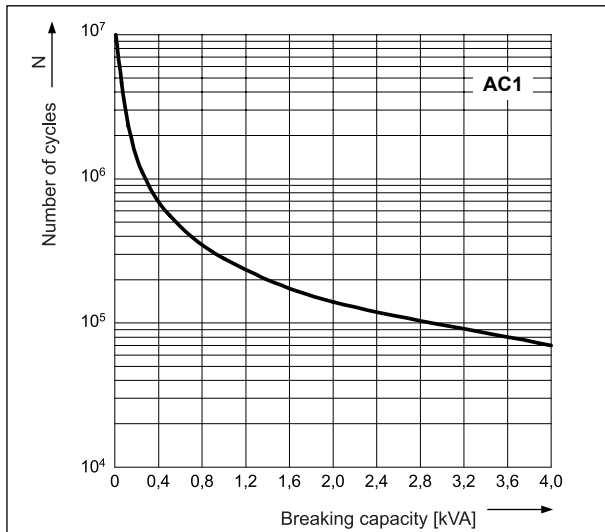

Electrical life reduction factor at AC inductive load

Fig. 2

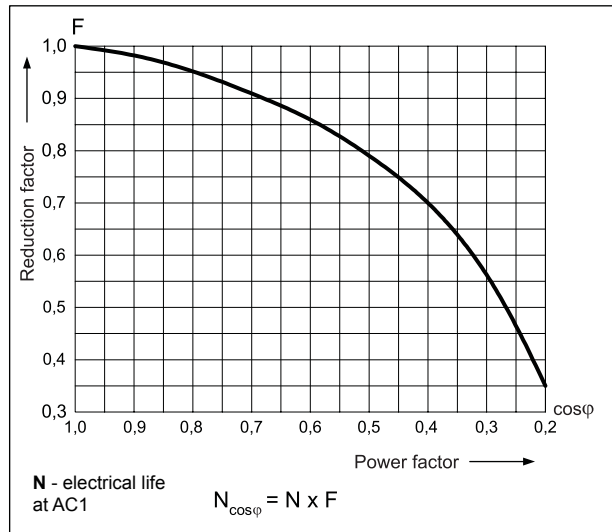

Max. DC resistive load breaking capacity

Fig. 3

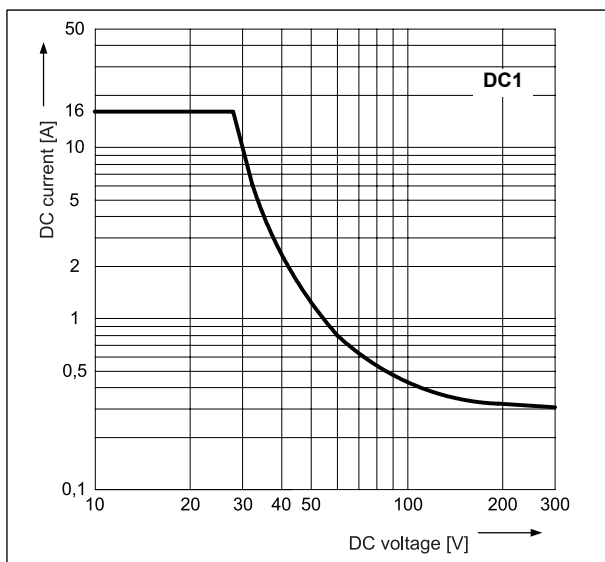

Coil operating range - DC

Fig. 4

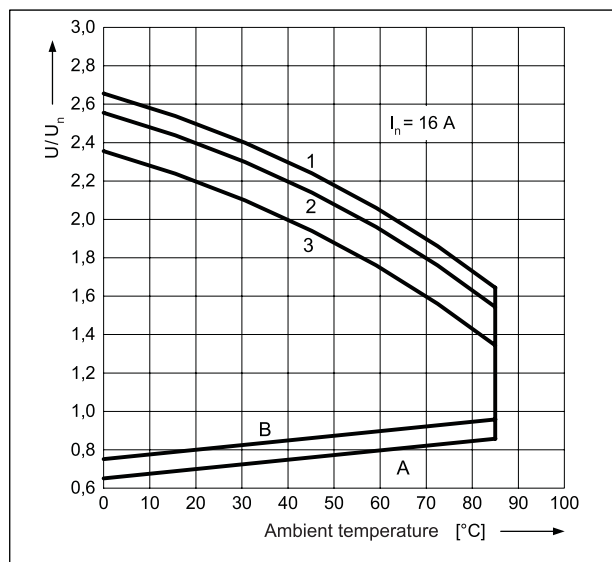

Coil operating range - AC 50 Hz

Fig. 5

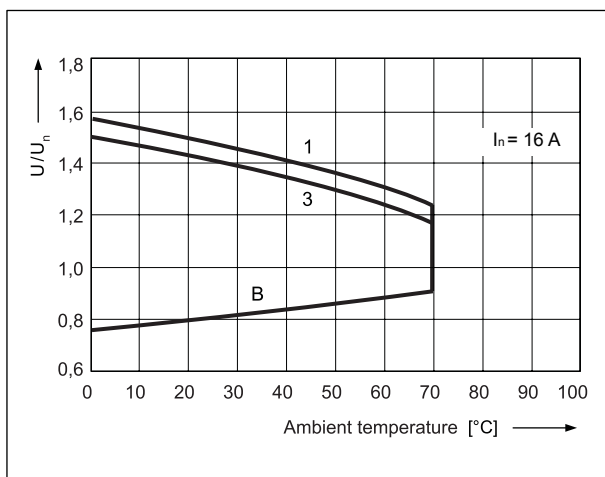

Description of Fig. 4 and 5

A - relations between make voltage and ambient temperature at no load on contacts. Coil temperature and ambient temperature are equal before coil energizing. Make voltage is not higher than the value read on Y axis (multiplication of rated voltage).

B - relations between make voltage and ambient temperature after initial coil heating up with $1,1 U_n$, at continues load of I_n on contacts. Make voltage is not higher than the value read on Y axis (multiplication of rated voltage).

1, 2, 3 - values on Y axis represent allowed overvoltage on coil at certain ambient temperature and contact load:

- 1 - no load
- 2 - 50% of rated load
- 3 - rated load

RM85

miniature relays

Mounting

Relays **RM85** ⑤ are designed for: • direct PCB mounting • screw terminals plug-in sockets **GZT80** ④ ⑤ and **GZM80** ④ ⑤ with clip **GZT80-0040** or **GZM80-0041**; plug-in sockets **GZS80** ④ ⑤ with clip **GZS-0040** or **GZM80-0041**, 35 mm rail mount acc. to PN-EN 60715 or on panel mounting with one M3 screw • spring terminals plug-in sockets **GZMB80** ④ ⑤ with clip **GZMB80-0040** or **GZM80-0041**, 35 mm rail mount acc. to P-EN 60715. Signalling / protecting modules **type M...** are available with sockets (see page 9) • plug-in sockets for PCB mounting **EC 50** with clip **MP16-2**, MH16-2; plug-in sockets **PW80** with clip **MH16-2**; plug-in sockets **GD50** with clip **MP16-2**, GD-0016, MH16-2.

⑤ For special version - relays in transparent cover: the distance of min. 5 mm between the mounting relays.

④ Loads above 12 A (GZT80, GZM80) or 10 A (GZS80, GZMB80) require bridging pairs of terminals: 11 with 21, 12 with 22, 14 with 24 - see page 3.

⑤ Plug-in sockets **GZT80**, **GZM80**, **GZS80** may be linked with interconnection strip type **ZGGZ80** (see page 10).

⑥ For sockets **GZMB80** - see page 7 (wire connection).

Ordering codes

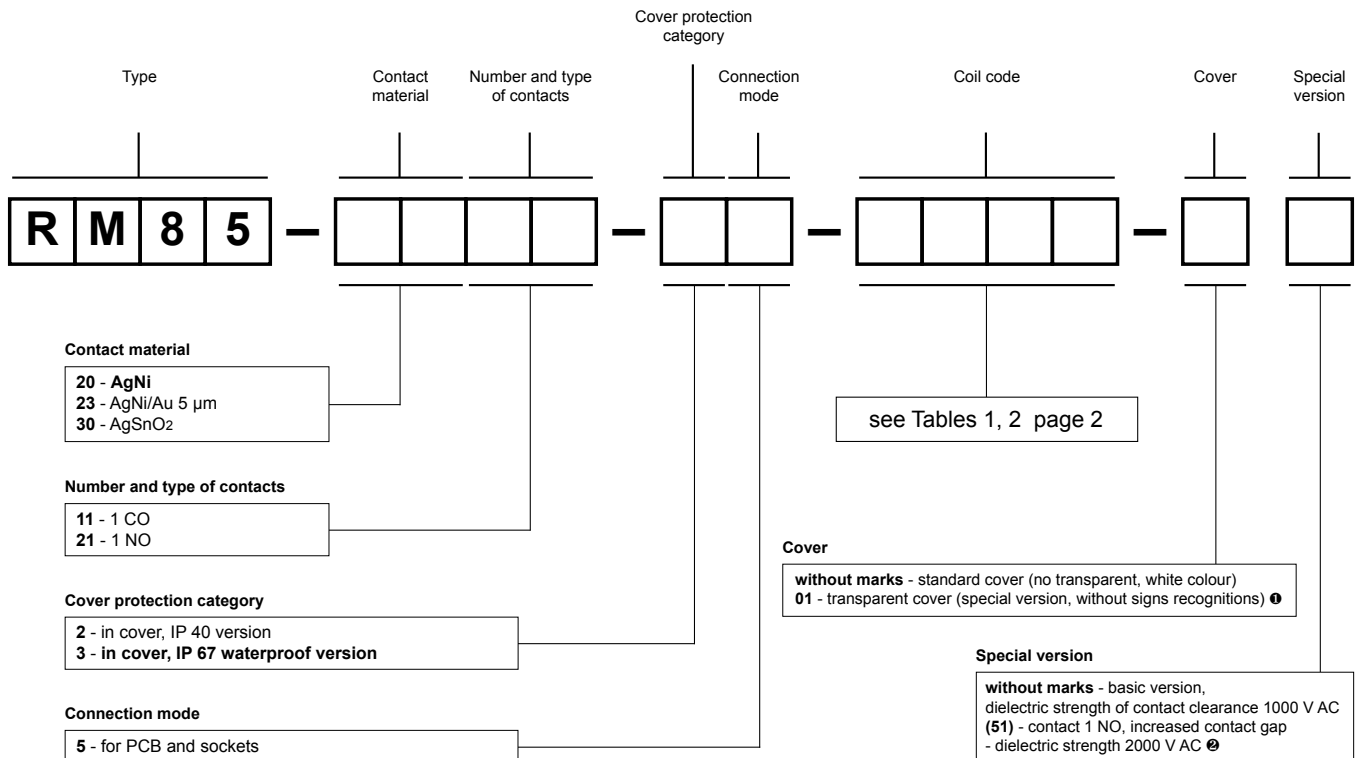

① For special version - relays in transparent cover: only available with IP 40 and RTII, operating temperature -40...+70 °C

② For special version with contact 1 NO: relays with increased contact gap, dielectric strength 2000 V AC

Examples of ordering code:

RM85-3011-25-5024

relay **RM85**, for PCB and sockets, one changeover contact, contact material AgSnO₂, coil voltage 24 V AC 50/60 Hz, in standard cover (no transparent, white colour) IP 40

RM85-2011-25-1012-01

relay **RM85**, for PCB and sockets, one changeover contact, contact material AgNi, coil voltage 12 V DC, in transparent cover (special version, without signs recognitions) IP 40

RM85-2321-35-1024 (51)

relay **RM85**, special version with increased contact gap, for PCB and sockets, one normally open contact, contact material AgNi/Au 5 µm, coil voltage 24 V DC, in standard cover (no transparent, white colour) IP 67

Plug-in sockets and accessories

GZT80

For RM84, RM85, RM85 inrush, RM85 105 °C sensitive, RMB841, RMB851, RM87L, RM87L sensitive, RM87P, RM87P sensitive

Screw terminals
Max. tightening moment for the terminal: 0,7 Nm
35 mm rail mount
acc. to PN-EN 60715
or on panel mounting
75,3 x 15,5 x 61(67) mm
Two poles, 5 mm pinout
12 A, 300 V AC



Connection diagrams ⑧

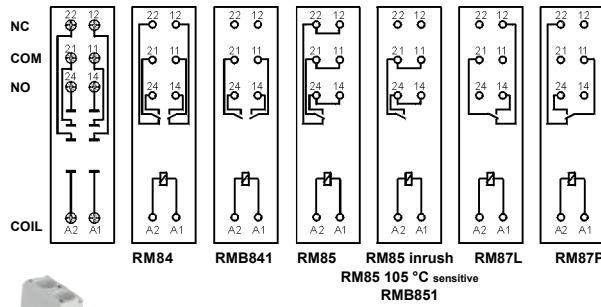

Accessories ① ZGGZ80 GZM80-0041

Dimensions

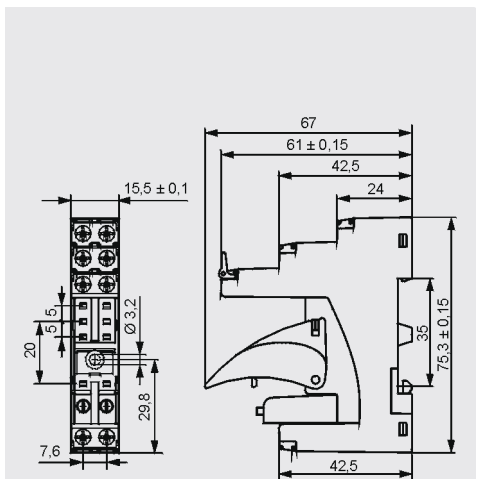

GZM80

For RM84, RM85, RM85 inrush, RM85 105 °C sensitive, RMB841, RMB851, RM87L, RM87L sensitive, RM87P, RM87P sensitive

Screw terminals
Max. tightening moment for the terminal: 0,7 Nm
35 mm rail mount
acc. to PN-EN 60715
or on panel mounting
78,1 x 15,9 x 61(66,5) mm
Two poles, 5 mm pinout
12 A, 300 V AC



Connection diagrams ⑧

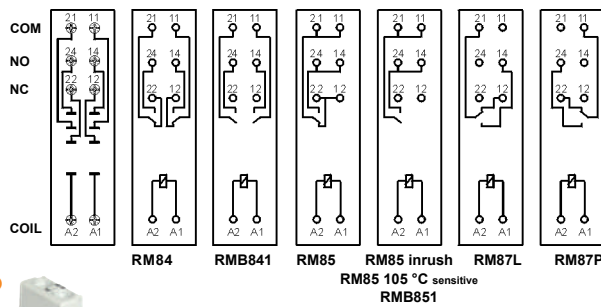

Accessories ① ZGGZ80 GZM80-0041

Dimensions

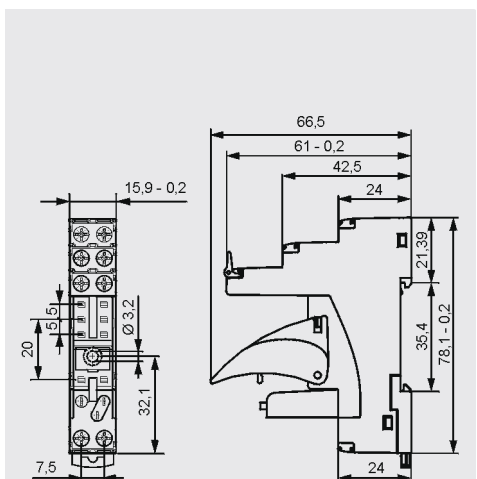

GZS80

For RM84, RM85, RM85 inrush, RM85 105 °C sensitive, RMB841, RMB851, RM87L, RM87L sensitive, RM87P, RM87P sensitive

Screw terminals
Max. tightening moment for the terminal: 0,5 Nm
35 mm rail mount
acc. to PN-EN 60715
or on panel mounting
76,8 x 15,8 x 42,5(57,1) mm
Two poles, 5 mm pinout
10 A, 300 V AC



Connection diagrams ⑧

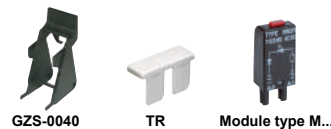
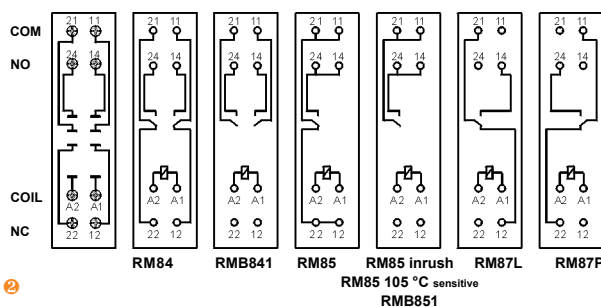

Accessories ① ZGGZ80 GZM80-0041

Dimensions

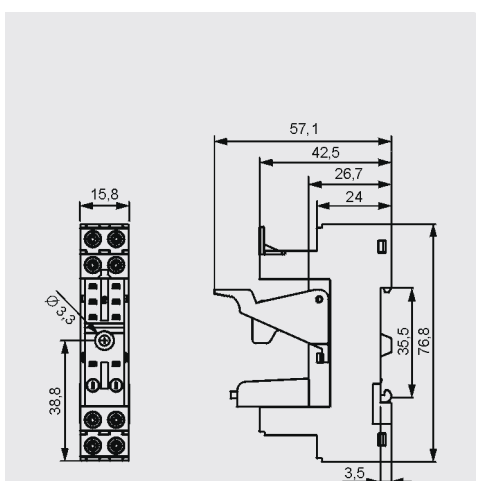

① Mounting and sub-assemblies of accessories in the socket - see page 8. Signalling / protecting modules type M... - see page 9. ② In the bracket the height of socket with retainer / retractor clip is shown. ③ For RM85, RM85 inrush, RM85 105 °C sensitive, RMB851: loads above 12 A (GZT80, GZM80) or 10 A (GZS80, GZM80) require bridging pairs of terminals: 11 with 21, 12 with 22, 14 with 24 - see page 3; For RMB841, RMB851 - see www.repol.com.pl (energizing of bistable relays)

Plug-in sockets and accessories

GZMB80

For RM84, RM85, RM85 inrush, RM85 105 °C sensitive, RMB841, RMB851, RM87L, RM87L sensitive, RM87P, RM87P sensitive

Spring terminals
Max. cross section of the cables:
1 x 0,2...1,5 mm²
(1 x 24...16 AWG)
Length of the cable deinsulation: 9...11 mm

35 mm rail mount
acc. to PN-EN 60715
97 x 16 x 45,2(69) mm
Two poles, 5 mm pinout
10 A, 300 V AC

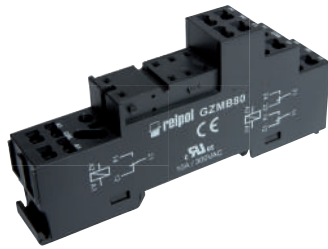

GZMB80-0040



TR



Module type M...



GZM80-0041

Connection diagrams ⑧

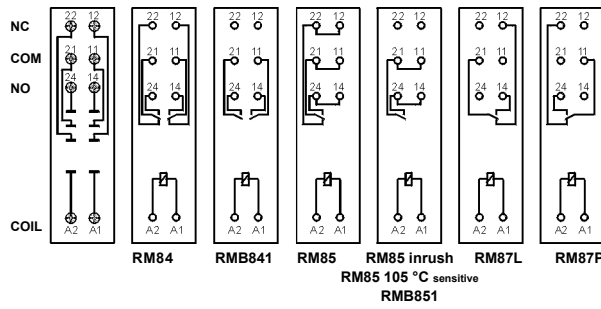

Dimensions

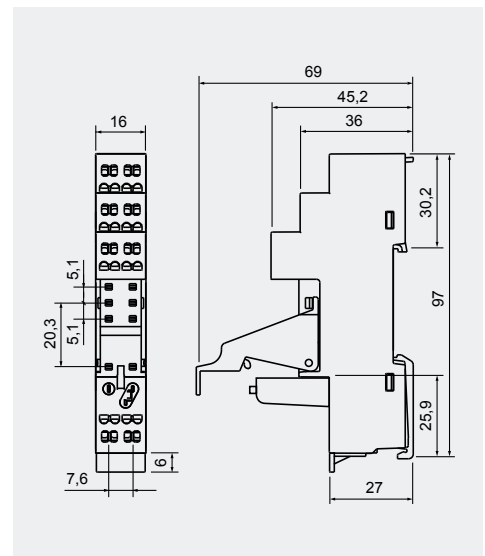

The drawings present the sequence of operations in course of inserting wires to the spring terminal, and the recommended screwdriver to be used for opening of case springs, comply with the DIN 5264 FORM „A”.

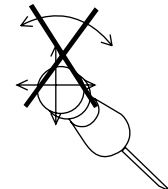
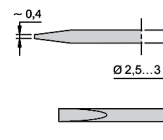
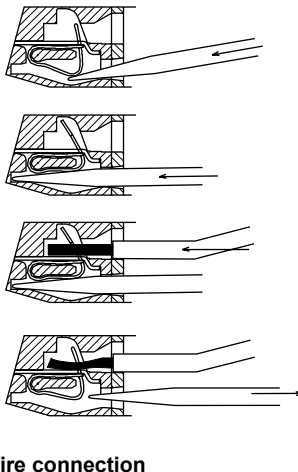

Accessories ①

Wire connection

EC 50

For RM84, RM85, RM85 inrush, RM85 105 °C sensitive, RMB841, RMB851, RM87L, RM87L sensitive, RM87P, RM87P sensitive, RM83, RM94

For PCB
31,3 x 12,7 x 9 mm
Two poles, 5 mm pinout
8 A, 300 V AC



Pinout

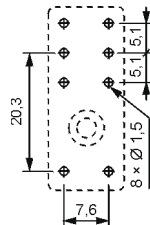

MP25-2

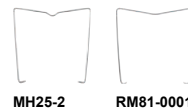

MH25-2

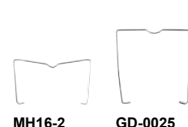

RM81-0001



MP16-2

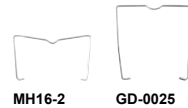

MH16-2

GD-0025

Dimensions

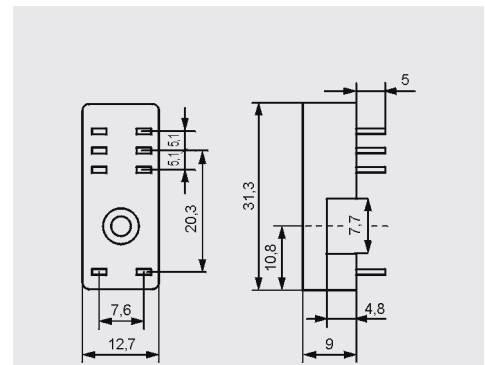

Accessories

Dimensions

PW80

For RM84, RM85, RM85 inrush, RM85 105 °C sensitive, RMB841, RMB851, RM87L, RM87L sensitive, RM87P, RM87P sensitive, RM83, RM94

For PCB
34,6 x 12,9 x 6,6 mm
Two poles, 5 mm pinout
8 A, 250 V AC



Pinout

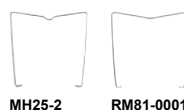
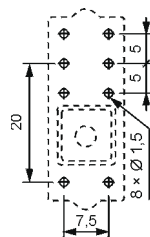

MH25-2



RM81-0001

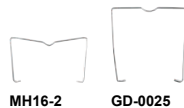

MH16-2



GD-0025

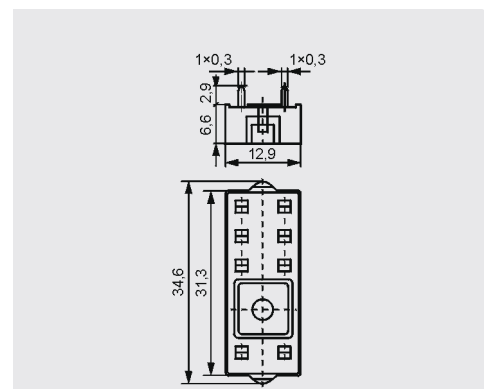

① Mounting and sub-assemblies of accessories in the socket - see page 8. Signalling / protecting modules type M... - see page 9. ② In the bracket the height of socket with retainer / retractor clip is shown. ③ For RM85, RM85 inrush, RM85 105 °C sensitive, RMB851: loads above 12 A (GZT80, GZM80) or 10 A (GZS80, GZMB80) require bridging pairs of terminals: 11 with 21, 12 with 22, 14 with 24 - see page 3; For RMB841, RMB851 - see www.repol.com.pl (energizing of bistable relays)

Plug-in sockets and accessories

GD50

For RM84, RM85, RM85 inrush, RM85 105 °C sensitive, RMB841, RMB851, RM87L, RM87L sensitive, RM87P, RM87P sensitive, RM83, RM94

For PCB
31,5 x 13 x 9 mm
Two poles, 5 mm pinout
8 A, 300 V AC



Pinout

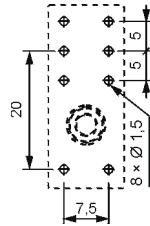

RM81-0001



MP25-2

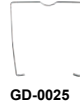

GD-0025



MH25-2



MP16-2



GD-0016



MH16-2

Accessories

Dimensions

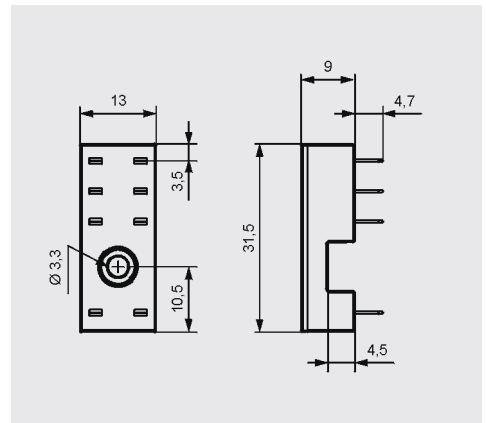

Mounting and sub-assemblies of the relay and accessories in the socket

Retainer / retractor clip

Electromagnetic relay

Signalling / protecting module type M...

Screw terminals plug-in socket

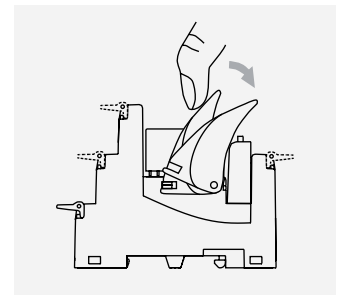

Removing the relay from the socket with a retractor / retractor clip

Description plate

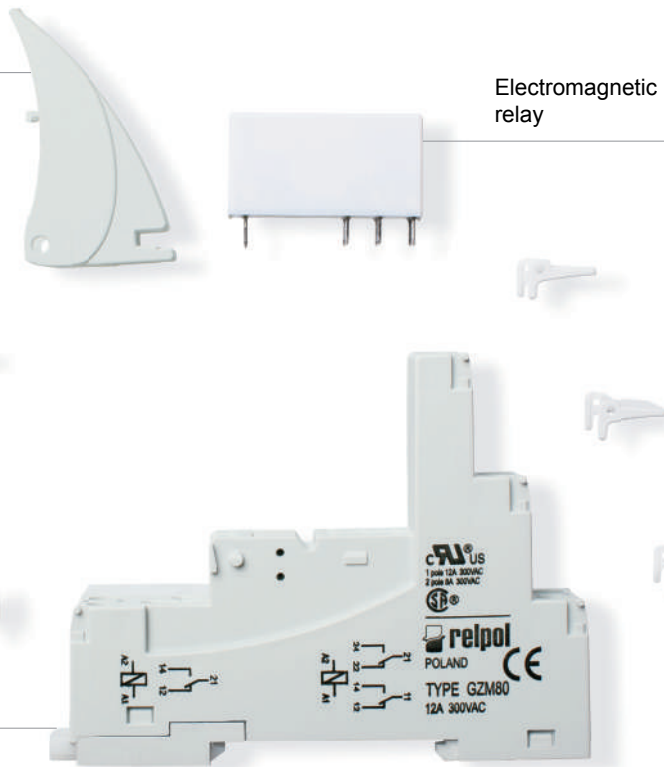

PRECAUTIONS:

1. Ensure that the parameters of the product described in its specification provide a safety margin for the appropriate operation of the device or system and never use the product in circumstances which exceed the parameters of the product. 2. Never touch any live parts of the device. 3. Ensure that the product has been connected correctly. An incorrect connection may cause malfunction, excessive heating or risk of fire. 4. In case of any risk of any serious material loss or death or injuries of humans or animals, the devices or systems shall be designed so to equip them with double safety system to guarantee their reliable operation.

Signalling / protecting modules type M...

For sockets type:

GZT80, GZM80, GZS80, GZMB80, GZT92, GZM92, GZS92, ES 32, GZT2, GZM2, GZMB2, GZT3, GZM3, GZT4, GZM4, GZMB4

Modules type M... are parallelly connected with relay coil.

Polarity P: -A1/+A2. Polarity N: +A1/-A2.

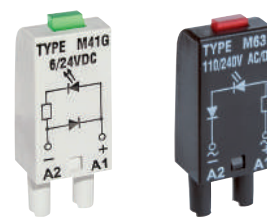

Modules type M...	Layout	Voltage	Type of module ① ②
Module D (polarization P) It limits overvoltage on DC coils.		6/230 V DC	M21P
Module D (polarization N) It limits overvoltage on DC coils.		6/230 V DC	M21N
Module LD (polarization P) It limits overvoltage on DC coils. Coil energizing indication.		6/24 V DC 24/60 V DC 110/230 V DC	M31R, M31G M32R, M32G M33R, M33G
Module LD (polarization N) It limits overvoltage on DC coils. Coil energizing indication.		6/24 V DC 24/60 V DC 110/230 V DC	M41R, M41G M42R, M42G M43R, M43G
Module RC It protects against EMC disturbance. It limits overvoltage.		6/24 V AC 24/60 V AC 110/240 V AC	M51 M52 M53
Module L Coil energizing indication.		6/24 V AC/DC 24/60 V AC/DC 110/230 V AC/DC	M61R, M61G M62R, M62G M63R, M63G
Module LV It limits overvoltage on AC and DC coils. Coil energizing indication.		6/24 V AC/DC 24/60 V AC/DC 110/230 V AC/DC	M91R, M91G M92R, M92G M93R, M93G
Module V It limits overvoltage on AC and DC coils. No indication.		24 V AC 130 V AC 230 V AC	M71 M72 M73
Module R It limits overvoltage on AC coils.		110/230 V AC	M103

① M...R - LED red, M...G - LED green

② When ordering modules indicate their color: gray or black.

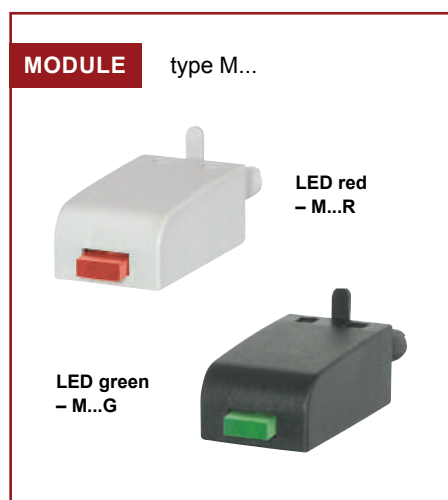

Interconnection strips ZGGZ80



PI85-...-00L.
(RM85 + GZM80)

ZGGZ80

ZGGZ80 for:

Plug-in sockets	Relays for plug-in sockets	Interface relays ^③
GZT80	RM84, RM85, RM85 inrush, RM85 105 °C sensitive, RMB841, RMB851, RM87L ^④ , RM87P ^④ , RM87N ^④	PI84-...-M..G (RM84 + GZT80)
GZM80		PI84-...-00L. (RM84 + GZM80)
GZS80		PI85-...-M..G (RM85 + GZT80)
GZT92		PI85-...-00L. (RM85 + GZM80)
GZM92		
GZS92		
ES 32	RM96 1 CO	

^③ Interface relay PI84 (PI85) is offered as a set: plug-in socket GZT80 or GZM80 + miniature relay RM84 (RM85) + signalling / protecting module type M... + retainer / retractor clip GZT80-0040 + description plate GZT80-0035. ^④ Also versions RM87. sensitive

Interconnection strip ZGGZ80

- designed for the co-operation with plug-in sockets of miniature relays and with interface relays PI84 and PI85, which are equipped with screw terminals; sockets and relays are mounted on 35 mm rail mount acc. to PN-EN 60715,
- bridges common input signals (coil terminals A1 or A2) or output signals - see photo at the top,
- maximum permissible current is 10 A / 250 V AC,
- possibility of connection of 8 sockets or relays,
- colours of strips: **ZGGZ80-1** grey, **ZGGZ80-2** black.

